

Operating Instructions Air Conditioner



Model No.

INDOOR UNIT

Wall Mounted (Type K2)

S-45MK2E5A
S-56MK2E5A
S-73MK2E5A
S-106MK2E5A

• Connectable outdoor unit lineup

This booklet is the operating instructions for indoor unit. Regarding the outdoor unit, see the operating instructions supplied with the outdoor unit.

OUTDOOR UNIT

mini VRF (Type LE1, LE2)

2WAY VRF (Type ME2)

3WAY VRF (Type MF2)



ENGLISH

2 ~ 9

Before operating the unit, read these operating instructions thoroughly and keep them for future reference.

E_{NGLISH}

FRANÇAIS

10 ~ 17

Avant d'utiliser l'appareil, lisez ce mode d'emploi dans son intégralité et conservez-le pour toute référence ultérieure.

F_{RANÇAIS}

ESPAÑOL

18 ~ 25

Antes de operar la unidad, lea atentamente estas instrucciones de funcionamiento y guárdelas para futuras consultas.

E_{SPAÑOL}

DEUTSCH

26 ~ 33

Bevor Sie das Gerät in Betrieb nehmen, lesen Sie bitte diese Bedienungsanleitung aufmerksam durch und bewahren Sie sie für die künftige Verwendung auf.

D_{EUTSCH}

ITALIANO

34 ~ 41

Prima di utilizzare l'unità, leggere a fondo queste istruzioni per l'uso e conservarle come riferimento futuro.

I_{TALIANO}

NEDERLANDS

42 ~ 49

Lees deze gebruiksinstructies goed door voor u het apparaat gebruikt en bewaar ze voor toekomstig gebruik.

N_{EDERLANDS}

PORTUGUÊS

50 ~ 57

Antes de utilizar o aparelho, leia completamente este manual de instruções e guarde-o para futuras referências.

P_{ORTUGUÊS}

ΕΛΛΗΝΙΚΑ

58 ~ 65

Πριν θέσετε τη μονάδα σε λειτουργία, διαβάστε πολύ καλά αυτές τις οδηγίες χρήσης και διατηρήστε τις για μελλοντική αναφορά.

E_{ΛΛΗΝΙΚΑ}

БЪЛГАРСКИ

66 ~ 73

Преди да започнете експлоатация на този уред, прочетете внимателно тези инструкции и ги запазете, за да можете да правите справки с тях и в бъдеще.

B_{ЪЛГАРСКИ}

TÜRKÇE

74 ~ 81

Üniteni çalıştırmadan önce bu çalıştırma talimatlarını iyice okuyun ve gelecekte başvurmak için saklayın.

T_{ÜRKÇE}

РУССКИЙ

82 ~ 89

Перед использованием этого устройства внимательно прочитайте настоящую инструкцию по эксплуатации и сохраните ее для дальнейших справок.

P_{УССКИЙ}

УКРАЇНСЬКА

90 ~ 97

Уважно прочитайте цю інструкцію з експлуатації перед тим, як увімкнути пристрій, та збережіть її на майбутнє.

Y_{КРАЇНСЬКА}

B.INDONESIA

98 ~ 105

Sebelum mengoperasikan unit, baca petunjuk pengoperasian ini secara menyeluruh dan simpan untuk referensi mendatang.

B_{.INDONESIA}

Thank you for purchasing this Panasonic product.
 This product is a commercial air conditioner indoor unit.
 Installation Instructions attached.

Contents

- Safety Precautions 2
- Precautions for Use 4
- Names of Parts 5

- Maintenance 6
- Troubleshooting 7
 - Before Requesting Services 8
 - Operation Mechanism 9

- Specifications 107
 - Indoor unit 107
 - Corresponding language table 108

Product Information

If you have problems or questions concerning your Air Conditioner, you will need the following information. Model and serial numbers are on the nameplate.

Model No.
Serial No.
Date of purchase
Dealer's address
Phone number

Safety Precautions

The following symbols used in this manual, alert you to potentially dangerous conditions to users, service personnel or the appliance:

	WARNING This symbol refers to a hazard or unsafe practice which can result in severe personal injury or death.
	CAUTION This symbol refers to a hazard or unsafe practice which can result in personal injury or product or property damage.
	Prohibited matters
	Matters to be observed

- Read these Operating Instructions carefully before using this air conditioner. If you still have any difficulties or problems, consult your dealer for help.
- This air conditioner is designed to give you comfortable room conditions. Use this only for its intended purpose as described in these Operating Instructions.

! WARNING

Confirm to authorized dealer or specialist on usage of specified refrigerant type. Using of refrigerant other than the specified type may cause product damage, burst and injury etc.

This air conditioner has no ventilator for intaking fresh air from outdoors. You must open doors or windows frequently when you use gas or oil heating appliances in the same room, which consume a lot of oxygen from the air. Otherwise there is a risk of suffocation in an extreme case.

Never use or store gasoline or other flammable vapor or liquid near the air conditioner — it is very dangerous.

Do not use this appliance in a potentially explosive atmosphere.

Never touch the unit with wet hands.

Do not insert your fingers or other objects into the air conditioner indoor or outdoor unit, rotating parts may cause injury.

If the refrigerant comes in contact with a flame, it produces a toxic gas.

For safety, be sure to turn the air conditioner off and also to disconnect the power before cleaning or servicing.

Pull off the power plug from a receptacle, or switch off the breaker, or switch off the power disconnecting mean to isolate the air conditioner from the main power supply in case of emergency.

Do not clean inside the indoor and outdoor units by users. Engage authorized dealer or specialist for cleaning.



In case of malfunction of this appliance, do not repair by yourself. Contact to the sales dealer or service dealer for a repair.

CAUTION

 Provide a power outlet to be used exclusively for each unit, and a power supply disconnect, Earth Leakage Circuit Breaker (ELCB) or Residual Current Device (RCD) for overcurrent protection should be provided in the exclusive line.

Provide a power outlet exclusively for each unit, and full disconnection means having a contact separation in all poles must be incorporated in the fixed wiring in accordance with the wiring rules.

To prevent possible hazards from insulation failure, the unit must be grounded. 

 Do not use modified cord, joint cord, extension cord or unspecified cord to prevent overheating and fire.  

 Stop using the product when any abnormality/failure occurs and disconnect the power plug or turn off the power switch and breaker. (Risk of smoke/fire/electric shock)

Examples of abnormality/failure:

- The ELCB trips frequently.
- The product sometimes does not start when turned on.
- The power is sometimes disconnected when the cord is moved.
- Burnt odor or abnormal noise is detected during operation.
- The body is deformed or abnormally hot.
- Water leaks from the indoor unit.
- Power cord or plug becomes abnormally hot.
- Fan speed cannot be controlled.
- The unit stops running immediately even if it is switched on for operation.
- The fan does not stop even if the operation is stopped.

Contact immediately your local dealer for maintenance/repair.

 Do not sit or step on the unit. You may fall down accidentally. 

 This appliance is intended to be used by expert or trained users in shops, in light industry and on farms, or for commercial use by lay persons.

This appliance is not intended for use by persons (including children) with reduced physical, sensory or mental capabilities, or lack of experience and knowledge, unless they have been given supervision or instruction concerning use of the appliance by a person responsible for their safety. Children should be supervised to ensure that they do not play with the appliance.

<for European market only>

This appliance can be used by children aged from 8 years and above and persons with reduced physical, sensory or mental capabilities or lack of experience and knowledge if they have been given supervision or instruction concerning use of the appliance in a safe way and understand the hazards involved. Children shall not play with the appliance. Cleaning and user maintenance shall not be made by children without supervision.



Keep the fire alarm and the air outlet at least 1.5m away from the unit.

Do not cool or heat the room too much if babies or invalids are present.

 Do not turn the air conditioner on and off from the power mains switch. Use the ON/OFF operation button.

Do not stick anything into the air outlet of the outdoor unit. This is dangerous because the fan is rotating at high speed. 

Do not touch the air inlet or the sharp aluminum fins of the outdoor unit. You may get injured. 

Do not stick any object into the FAN CASE. You may be injured and the unit may be damaged.  

NOTICE

- The compressor may occasionally stop during thunderstorms. The unit automatically recovers after a few minutes.
- The English text is the original instructions. Other languages are translation of the original instructions.

Precautions for Use

Installation

- This air conditioner must be installed properly by qualified installation technicians in accordance with the Installation Instructions provided with the unit.
- Before installation, check that the voltage of the electric supply in your home or office is the same as the voltage shown on the nameplate.

WARNING

Avoid the following locations for installation.

- Locations where smoke or combustible gas exists. Also locations of extremely high temperature such as a greenhouse.
- Locations where excessively high heat-generating objects are placed.

Attention:

- Avoid installing the outdoor unit where salty sea water can splash directly onto it or in sulphurous air near a spa. (To protect the air conditioner from heavy corrosion)

Information for Users on Collection and Disposal of Old Equipment and Used Batteries



These symbols on the products, packaging, and/or accompanying documents mean that used electrical and electronic products and batteries should not be mixed with general household waste.

For proper treatment, recovery and recycling of old products and used batteries, please take them to applicable collection points, in accordance with your national legislation and the Directives 2002/96/EC and 2006/66/EC. By disposing of these products and batteries correctly, you will help to save valuable resources and prevent any potential negative effects on human health and the environment which could otherwise arise from inappropriate waste handling.

For more information about collection and recycling of old products and batteries, please contact your local municipality, your waste disposal service or the point of sale where you purchased the items.

Penalties may be applicable for incorrect disposal of this waste, in accordance with national legislation.

For business users in the European Union
If you wish to discard electrical and electronic equipment, please contact your dealer or supplier for further information.

[Information on Disposal in other Countries outside the European Union]

These symbols are only valid in the European Union. If you wish to discard these items, please contact your local authorities or dealer and ask for the correct method of disposal.

Wiring

- All wiring must conform to the local electrical codes. (Consult your dealer or a qualified electrician for details.)
- Each unit must be properly grounded with a ground (or earth) wire or through the supply wiring.
- Wiring must be done by a qualified electrician.

Operation Preparation

Turn the power mains on 5 hours before the start of operation.

(For warm-up)

- Leave the power mains ON for continuous use.



NOTE

Pull off the power plug from a receptacle, or switch off the breaker, or switch off the power disconnecting mean to isolate the air conditioner from the main power supply when not in use for a long time.

Operation Condition

Use this air conditioner under the following temperature range.

Outdoor Unit	Indoor temperature range	Outdoor temperature range
mini VRF (Type LE1, LE2)		
Cooling	14°C ~ 25°C (*WBT)	-10°C ~ 46°C (*DBT) -10°C ~ 43°C (*DBT)*1
Heating	16°C ~ 30°C (*DBT)	-20°C ~ 18°C (*WBT)
2WAY (Type ME2)		
Cooling	14°C ~ 25°C (*WBT)	-10°C ~ 52°C (*DBT) -10°C ~ 43°C (*DBT)*1
Heating	16°C ~ 30°C (*DBT)	-25°C ~ 18°C (*WBT)
3WAY (Type MF2)		
Cooling	14°C ~ 25°C (*WBT)	-10°C ~ 46°C (*DBT) -10°C ~ 43°C (*DBT)*1
Heating	15°C ~ 30°C (*DBT)	-20°C ~ 18°C (*WBT)
Cooling & Heating	—	-10°C ~ 24°C (*DBT)

*DBT: Dry bulb temperature

*WBT: Wet bulb temperature

*1: The maximum allowable temperature of this air conditioning system is reduced to 43°C when using the existing R22 pipe.



Note for the battery symbol (bottom two symbol examples):

This symbol might be used in combination with a chemical symbol. In this case it complies with the requirement set by the Directive for the chemical involved.

Names of Parts

INDOOR UNIT

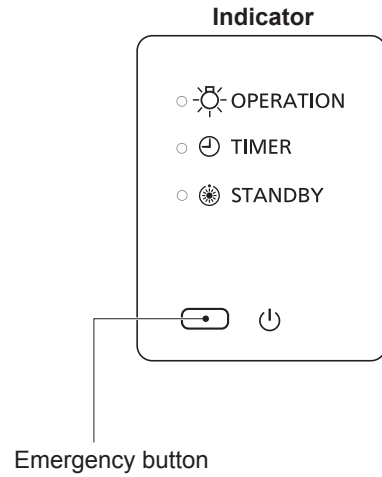
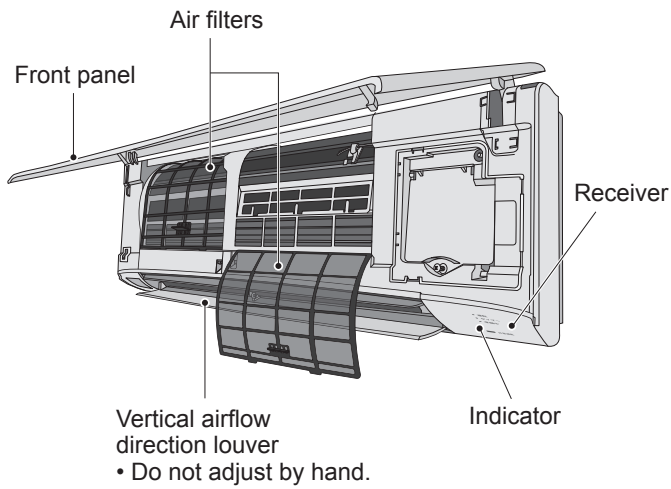

E
NGLISH

Optional

Wireless Remote Controller



Model No.
CZ-RWSK2 (Type K2)

Timer Remote Controller

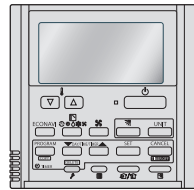

Model No.
CZ-RTC4
For all indoor
units

High-spec Wired Remote Controller



Model No.
CZ-RTC5A
For all indoor
units

Read the Operating Instructions included with the Remote Controller.

■ Operation & Adjusting Airflow Direction

Refer to the Operating Instructions attached to the Remote Controller.

Maintenance

⚠ WARNING

- For safety, be sure to turn the air conditioner off and disconnect the power before cleaning. (Otherwise, electric shock or injury may result because the fan is rotating at high speed.)
- Do not pour water on the indoor unit. (This may damage the internal components and cause an electric shock hazard.)

- The internal coil and other components of the outdoor unit must be cleaned periodically.
 - Consult your dealer or service center.

■ Air Filter Maintenance

It is recommended that the air filter be cleaned when the  (Filter) appears on the display. Clean the filter frequently for best performance in the area of dusty or oil spots regardless of filter status.

■ Cleaning

Cleaning instructions :

- Do not use benzene, thinner or scouring powder.
- Use only soap (≈pH7) or neutral household detergent.
- Do not use water hotter than 40°C.

Indoor unit :

Wipe the unit gently with a soft, dry cloth.

Air filters :

- Air filters cleaning is needed every two weeks.
- Wash/rinse the filters gently with water to avoid damage to the filter surface.
- Dry the filters thoroughly under the shade, away from fire or direct sunlight.
- Replace any damage filter.

NOTE

- Clean the filter regularly for best performance and to reduce power consumption.
- Please consult your nearest dealer for seasonal inspection.

■ How to remove

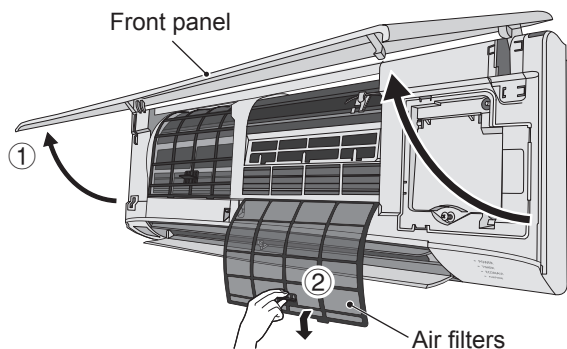

⚠ CAUTION

- Never use solvents or harsh chemicals. Also, do not wipe plastic parts using very hot water. (This may cause deformation or change in colour.)
- Some metal edges and fins are sharp. Be careful when you clean those parts. (Injury may result.)
- Use a firm stool or ladder when cleaning an indoor unit installed high locations.

Timer Remote Controller

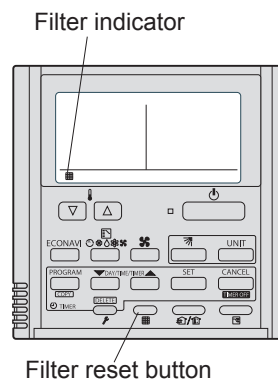

High-spec Wired Remote Controller

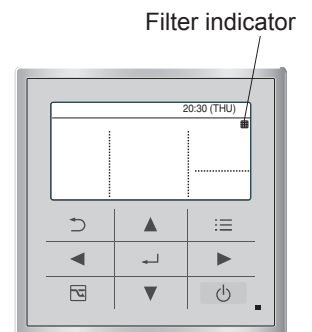

■ After Cleaning

1. After the air filter is cleaned, reinstall it in its original position.

Be sure to reinstall in reverse order.

2. [In the case of Timer Remote Controller]

Press the Filter reset button.

The  (Filter) indicator on the display goes out.

[In the case of High-spec Wired Remote Controller]

Refer to the Operating Instructions attached to the optional High-spec Wired Remote Controller.

Troubleshooting

Check before consulting or requesting services.

		Symptom	Cause / Action
Indoor unit	Noise	Sound like streaming water is heard during operation or after operation.	<ul style="list-style-type: none"> • Sound of refrigerant liquid flowing inside unit • Sound of drainage water through drain pipe
		Cracking noise is heard during operation or when operation stops.	<ul style="list-style-type: none"> • Sound due to temperature changes of parts
	Discharged air smells during operation.		<ul style="list-style-type: none"> • Indoor odor components, cigarette odor and cosmetic odor accumulated in the air conditioner and its air is discharged. • The unit inside is dirty. (Contact your dealer.)
	Dewdrops accumulate near the air outlet during cooling operation.		<ul style="list-style-type: none"> • Internal moisture is cooled by cool wind and accumulates as dewdrops.
	Fog occurs during cooling operation.		<ul style="list-style-type: none"> • If the air conditioner has been installed at places such as restaurants where large amounts of oil mist exist, cleaning is necessary because the unit inside (heat exchanger) is dirty. (Contact your dealer.)
	Fog occurs during heating operation.		<ul style="list-style-type: none"> • Defrost operation is in process.
	The fan is rotating for a while even though operation stops.		<ul style="list-style-type: none"> • Fan rotation makes operation smooth. • The fan may rotate to dry the heat exchanger depending on the setting.
	Airflow direction	Airflow direction changes while operating. Airflow direction cannot be set. Airflow direction cannot be changed.	<ul style="list-style-type: none"> • When air discharge temperature is low during heating operation, or during defrost operation, horizontal wind flow is made automatically.
		The flap moves several times after the direction is changed.	<ul style="list-style-type: none"> • The flap moves to the standard position once, and then turns to the set airflow direction.
	Dust is discharged.		<ul style="list-style-type: none"> • Dust accumulated inside the indoor unit is discharged.
At the initial high-speed operation, the fan sometimes rotates faster than the setting speed. (3 to 30 minutes)		<ul style="list-style-type: none"> • This is for operation check in order to confirm whether the fan motor rotation is within the range of use. 	
Outdoor unit	No operation (When the power is turned on immediately / When operation is stopped and resumed immediately)		<ul style="list-style-type: none"> • Operation is not activated for the first approx. 3 minutes because the compressor protection circuit is activated.
	Noise occurs during heating operation.		<ul style="list-style-type: none"> • Defrost operation is in process.
	Steam comes out during heating operation.		
	The fan continues to rotate even after the operation is stopped using the remote controller.		<ul style="list-style-type: none"> • This is for smooth operation.

Troubleshooting

Before Requesting Services

Symptom	Cause	Action
The air conditioner does not operate although the power is turned on.	Power failure or after power failure	Press the power ON/OFF button on the remote controller.
	The operation (power) button is turned off.	<ul style="list-style-type: none"> • If the breaker is turned off, turn the power on. • If the breaker has been tripped, consult your dealer without turning it on.
	Fuse blow out.	Contact your dealer.
Poor cooling or heating performance	The air intake or air outlet of indoor and outdoor units is clogged with dust.	Remove the dust.
	The fan speed switch is set to "Low".*	Change to "Medium" or "High".*
	Improper temperature settings	See "Tips for Energy Saving". (P.9)
	The room is exposed to direct sunlight in cooling mode.	
	Doors or windows are open.	
	The air filter is clogged.	See "Maintenance". (P.6)
	Too many heat sources in the room in cooling mode.	Use minimum heat sources and in a short time.
Too many people in the room in cooling mode.	Lower the temperature setting or change the fan speed to "Medium" or "High".*	

* Regarding the remote control display, see the page 107.

If your air conditioner does not work properly even after checking each item of "Before Requesting Services" and "Troubleshooting"



- Stop the operation immediately and turn the power off. Then contact your dealer and report the serial number and symptom. You also report if the inspection mark  and the letters E, F, H, L, P in combination with numbers appear on the LCD of the remote controller.
- Never repair the air conditioner by yourself since it is very dangerous for you to do so.

Operation Mechanism

■ Heating performance

- Since this air conditioner utilizes outside air for heating, its heating performance deteriorates as outside temperature decreases.
(Due to heat pump system)
→ In that case, use another heating appliance.

■ Defrosting

- This appliance may start defrosting operation to melt frost formed in the outdoor unit.
 - ① **Defrosting starts:** The indoor unit fan stops (or the speed becomes extremely slow).
→ “” (STANDBY) appears.
 - ② **Heating operation resumes after several minutes:** The indoor unit fan remains stopped (or it will run at a very slow speed) until the indoor heat exchanger coil warms up sufficiently.
→ “” (STANDBY) is shown.
 - ③ **Defrosting is complete:** The indoor unit fan starts operation.
→ “” (STANDBY) disappears.

■ “DRY” operation

- Once the room temperature reaches the level that was set, the outdoor unit repeats the cycle of turning on and off automatically.
- When the room temperature is more likely to reach the level that was set, the fan speed is set to “breeze” (light wind) automatically.
(To prevent the humidity in the room from rising again)

■ Should the power failure occurs while the unit is running

When the unit automatically resumes operation after temporary power failure, it uses the same settings before the power was cut off.

E
ENGLISH

Tips for Energy Saving

■ Avoid

- **Do not block the air intake and outlet of the unit. (If either is obstructed, the unit will not function well, causing malfunction.)**
- During cooling operation, use sunshades, blinds or curtains to prevent direct sunlight from entering the room.

■ Do

- Always keep the air filter clean. (A clogged filter will impair the performance of the unit.) → “Maintenance” (P.6)
- To prevent conditioned air from escaping, keep windows, doors and any other openings closed.

Important Information Regarding The Refrigerant Used

This product contains fluorinated greenhouse gases. Do not vent gases into the atmosphere.

Refrigerant type: R410A

GWP⁽¹⁾ value: 2088

⁽¹⁾ GWP = global warming potential

Periodical inspections for refrigerant leaks may be required depending on European or local legislation. Please contact your local dealer for more information.