



### INSTALLATION INSTRUCTIONS OUTDOOR UNIT

RATED CAPACITY	MODEL NAME	RATED CAPACITY	MODEL NAME
36	U-36PZ3E5	60	U-60PZ3E5
50	U-50PZ3E5	71	U-71PZ3E5



https://eu.datanavi.ac.smartcloud.panasonic.com/documents/

# CAUTION R32 REFRIGERANT

This Air Conditioner contains and operates with refrigerant R32. THIS PRODUCT MUST ONLY BE INSTALLED OR SERVICED BY QUALIFIED PERSONNEL. Refer to Commonwealth, State, Territory and local legislation, regulations, codes, installation & operating instructions, before the installation, maintenance and/or service of this product.

#### Refer to the indoor unit installation instruction manual for the indoor unit installation.

Note: Ensure to hand over this installation instruction manual to the person performing the installation and inform the customer to keep it properly stored.

- Refer to the caution items listed in "3. REFRIGERANT INSTALLATION" for the installation of the refrigerant piping and maintain strict control concerning the prevention of mixing impurities (water and mineral oils such as Suniso oils) with R32.
  - The indoor unit to be connected must be R32 compatible and be sure to check the catalogue, etc. for available models. The product may not operate properly if connected to other indoor units.
  - Please scan the above matrix two-dimensional (2D) barcode and read thoroughly for the detailed instruction.
- Panasonic will not be responsible for any accident or damage due to improper installation in any way not described in the detailed manuals. Malfunction caused by incorrect installation is also not covered by product warranty.

### SAFETY PRECAUTIONS

- Read the following "SAFETY PRECAUTIONS" carefully before installation.
- Electrical work must be installed by a licensed electrician. Be sure to use the correct rating of the power plug and main circuit for the model to be installed.
- The caution items stated here must be followed because these important contents are related to safety. The meaning of each indication used is as below. Incorrect installation due to ignoring of the instruction will cause harm or damage, and the seriousness is classified by the following indications.

	This indication shows the possibility of causing death or serious injury.
	This indication shows the possibility of causing injury or damage to properties only.

The items to be followed are classified by the symbols:

	Symbol with white background denotes item that is PROHIBITED.
	Symbol with dark background denotes item that must be carried out.

- Carry out test running to confirm that no abnormality occurs after the installation. Then, explain to user the operation, care and maintenance as stated in instructions. Please remind the customer to keep the operating instructions for future reference.

**WARNING**

Do not use means to accelerate the defrosting process or to clean, other than those recommended by the manufacturer. Any unfit method or using incompatible material may cause product damage, burst and serious injury.

Do not install outdoor unit near handrail of veranda. When installing air-conditioner unit on veranda of a high rise building, child may climb up to outdoor unit and cross over the handrail causing an accident.

Do not use unspecified cord, modified cord, joint cord or extension cord for power supply cord. Do not share the single outlet with other electrical appliances. Poor contact, poor insulation or over current will cause electrical shock or fire.

Do not tie up the power supply cord into a bundle by band. Abnormal temperature rise on power supply cord may happen.

Do not insert your fingers or other objects into the unit, high speed rotating fan may cause injury.

Do not sit or step on the unit, you may fall down accidentally.

Keep plastic bag (packaging material) away from small children, it may cling to nose and mouth and prevent breathing.

When installing or relocating air conditioner, do not let any substance other than the specified refrigerant, eg. air etc mix into refrigeration cycle (piping). Mixing of air etc. will cause abnormal high pressure in refrigeration cycle and result in explosion, injury etc.

Do not pierce or burn as the appliance is pressurized. Do not expose the appliance to heat, flame, sparks, or other sources of ignition. Else, it may explode and cause injury or death.

Do not add or replace refrigerant other than specified type. It may cause product damage, burst and injury etc.

- For R32 model, use new piping, flare nut and tools which is specified for R32 refrigerant. Using of existing (R22) piping, flare nut and tools may cause abnormally high pressure in the refrigerant cycle (piping), and possibly result in explosion and injury. For R32 and R410A, the same flare nut on the outdoor unit side and pipe can be use.
- Since the working pressure for R32/R410A is higher than that of refrigerant R22 models, replacing conventional piping and flare nuts on the outdoor unit side are recommended.
- If reuse piping is unavoidable, refer to instruction **REFRIGERANT INSTALLATION (INCASE OF REUSING EXISTING REFRIGERANT PIPING)**.
- Thickness for copper pipes used with R32 must be meet the requirement. Refer to **REFRIGERANT INSTALLATION** piping thickness table.
- It is desirable that the amount of residual oil less than 40 mg/10 m.

Engage authorized dealer or specialist for installation. If installation done by the user is incorrect, it will cause water leakage, electrical shock or fire.

For refrigeration system work, install according to this installation instructions strictly. If installation is defective, it will cause water leakage, electrical shock or fire.

Use the attached accessories parts and specified parts for installation. Otherwise, it will cause the set to fall, water leakage, fire or electrical shock.

Install at a strong and firm location which is able to withstand weight of the set. If the strength is not enough or installation is not properly done, the set will drop and cause injury.

For electrical work, follow the national regulation, legislation and this installation instructions. An independent circuit and single outlet must be used. If electrical circuit capacity is not enough or defect found in the electrical work, it will cause electrical shock or fire.

Do not use joint cable for indoor / outdoor connection cable. Use the specified indoor/outdoor connection cable, refer to instruction **Electrical Wiring** and connect tightly for indoor/outdoor connection. Clamp the cable so that no external force will have impact on the terminal. If connection or fixing is not perfect, it will cause heat up or fire at the connection.

Wire routing must be properly arranged so that control board cover is fixed properly. If control board cover is not fixed perfectly, it will cause fire or electrical shock.

This equipment is strongly recommended to be installed with Earth Leakage Circuit Breaker (ELCB) or Residual Current Device (RCD), with sensitivity of 30mA at 0.1 sec or less. Otherwise, it may cause electrical shock and fire in case of equipment breakdown or insulation breakdown.

During installation, install the refrigerant piping properly before running the compressor. Operation of compressor without fixing refrigeration piping and valves at opened position will cause suck-in of air, abnormal high pressure in refrigeration cycle and result in explosion, injury etc.

During pump down operation, stop the compressor before removing the refrigeration piping. Removal of refrigeration piping while compressor is operating and valves are opened will cause suck-in of air, abnormal high pressure in refrigeration cycle and result in explosion, injury etc.

Tighten the flare nut with torque wrench according to specified method. If the flare nut is over-tightened, after a long period, the flare may break and cause refrigerant gas leakage.

After completion of installation, confirm there is no leakage of refrigerant gas. It may generate toxic gas when the refrigerant contacts with fire.

Ventilate if there is refrigerant gas leakage during operation. It may cause toxic gas when the refrigerant contacts with fire.

Be aware that refrigerants may not contain an odour.

This equipment must be properly earthed. Earth line must not be connected to gas pipe, water pipe, earth of lightning rod and telephone. Otherwise, it may cause electrical shock in case of equipment breakdown or insulation breakdown.

**CAUTION**

Do not install the unit in a place where leakage of flammable gas may occur. In case gas leaks and accumulates at surrounding of the unit, it may cause fire.

Prevent liquid or vapor from entering sumps or sewers since vapor is heavier than air and may form suffocating atmospheres.

Do not release refrigerant during piping work for installation, re-installation and during repairing refrigeration parts. Take care of the liquid refrigerant, it may cause frostbite.

Do not install this appliance in a laundry room or other location where water may drip from the ceiling, etc.

Do not touch the sharp aluminium fin, sharp parts may cause injury.

Carry out drainage piping as mentioned in installation instructions. If drainage is not perfect, water may enter the room and damage the furniture.

Select an installation location which is easy for maintenance. Incorrect installation, service or repair of this air conditioner may increase the risk of rupture and this may result in loss damage or injury and/or property.

Power supply connection to the room air conditioner. Use power supply cord type designation 60245 IEC 57 or heavier cord. Connect the power supply cord of the air conditioner to a circuit breaker for the permanent connection. It must be a double pole switch with a minimum 3.0 mm contact gap. Power supply point should be in easily accessible place for power disconnection in case of emergency.

Installation work. It may need two people to carry out the installation work.

Keep any required ventilation openings clear of obstruction.

### PRECAUTION FOR USING R32 REFRIGERANT

- The basic installation work procedures are the same as conventional refrigerant (R410A, R22) models. However, pay careful attention to the following points:

**WARNING**

The appliance shall be stored, installed and operated in a well ventilated room with indoor floor area larger than  $A_{in}$  (m<sup>2</sup>) [refer to Check of Density Limit] and without any continuously operating ignition source. Keep away from open flames, any operating gas appliances or any operating electric heater. Else, it may explode and cause injury or death.

The mixing of different refrigerants within a system is prohibited. Models that use refrigerant R32 and R410A have a different charging port thread diameter to prevent erroneous charging with refrigerant R22 and for safety. Therefore, check beforehand. [The charging port thread diameter for R32 and R410A is 12.7 mm (1/2 inch).]

Ensure that foreign matter (oil, water, etc.) does not enter the piping. Also, when storing the piping, securely seal the opening by pinching, taping, etc. (Handling of R32 is similar to R410A.)

Operation, maintenance, repairing and refrigerant recovery should be carried out by trained and certified personnel in the use of flammable refrigerants and as recommended by the manufacturer. Any personnel conducting an operation, servicing or maintenance on a system or associated parts of the equipment should be trained and certified.

Any part of refrigerating circuit (evaporators, air coolers, AHU, condensers or liquid receivers) or piping should not be located in the proximity of heat sources, open flames, operating gas appliance or an operating electric heater.

The user/owner or their authorized representative shall regularly check the alarms, mechanical ventilation and detectors, at least once a year, where as required by national regulations, to ensure their correct functioning.

A logbook shall be maintained. The results of these checks shall be recorded in the logbook.

In case of ventilations in occupied spaces shall be checked to confirm no obstruction.

Before a new refrigerating system is put into service, the person responsible for placing the system in operation should ensure that trained and certified operating personnel are instructed on the basis of the instruction manual about the construction, supervision, operation and maintenance of the refrigerating system, as well as the safety measures to be observed, and the properties and handling of the refrigerant used.

The general requirement of trained and certified personnel are indicated as below:

- Knowledge of legislation, regulations and standards relating to flammable refrigerants; and,
- Detailed knowledge of and skills in handling flammable refrigerants, personal protective equipment, refrigerant leakage prevention, handling of cylinders, charging, leak detection, recovery and disposal; and,
- Able to understand and to apply in practice the requirements in the national legislation, regulations and Standards; and,
- Continuously undergo regular and further training to maintain this expertise.

Air-conditioner piping in the occupied space shall be installed in such a way to protect against accidental damage in operation and service.

Precautions shall be taken to avoid excessive vibration or pulsation to refrigerating piping.

Ensure protection devices, refrigerating piping and fittings are well protected against adverse environmental effects (such as the danger of water collecting and freezing in relief pipes or the accumulation of dirt and debris).

Expansion and contraction of long runs piping in refrigerating systems shall be designed and installed securely (mounted and guarded) to minimize the likelihood hydraulic shock damaging the system.

Protect the refrigerating system from accidental rupture due to moving furniture or reconstruction activities.

To ensure no leaking, field-made refrigerant joints indoors shall be tightness tested. The test method shall have a sensitivity of 5 grams per year of refrigerant or better under a pressure of at least 0.25 times the maximum allowable pressure (>1.04MPa, max 4.15MPa). No leak shall be detected.

**CAUTION**

- General**
  - Must ensure the installation of pipe-work shall be kept to a minimum. Avoid use dented pipe and do not allow acute bending.
  - Must ensure that pipe-work shall be protected from physical damage.
  - Must comply with national gas regulations, state municipal rules and legislation. Notify relevant authorities in accordance with all applicable regulations.
  - Must ensure mechanical connections be accessible for maintenance purposes.
  - In cases that require mechanical ventilation, ventilation openings shall be kept clear of obstruction.
  - When disposal of the product, do follow to the precautions in #11 and comply with national regulations.
  - In case of field charge, the effect on refrigerant charge caused by the different pipe length has to be quantified, measured and labelled. Always contact to local municipal offices for proper handling.
  - Ensure the actual refrigerant charge is in accordance with the room size within which the refrigerant containing parts are installed.
  - Ensure refrigerant charge not to leak.
  - Wear appropriate protective equipment, including respiratory protection, as conditions warrant.
  - Keep all sources of ignition and hot metal surfaces away.
- Servicing**
  - Qualification of workers**
    - Any qualified person who is involved with working on or breaking into a refrigerant circuit should hold a current valid certificate from an industry-accredited assessment authority, which authorizes their competence to handle refrigerants safely in accordance with an industry recognized assessment specification.
    - Servicing shall only be performed as recommended by the equipment manufacturer. Maintenance and repair requiring the assistance of other skilled personnel shall be carried out under the supervision of the person competent in the use of flammable refrigerants.
    - Servicing shall be performed only as recommended by the manufacturer.
    - The system is inspected, regularly supervised and maintained by a trained and certified service personnel who is employed by the person user or party responsible.
  - Checks to the area**
    - Prior to beginning work on systems containing flammable refrigerants, safety checks are necessary to ensure that the risk of ignition is minimised. For repair to the refrigerating system, the precautions in #2-3 to #2-7 must be followed before conducting work on the system.
  - Work procedure**
    - Work shall be undertaken under a controlled procedure so as to minimize the risk of a flammable gas or vapour being present while the work is being performed.
  - General work area**
    - All maintenance staff and others working in the local area shall be instructed and supervised on the nature of work being carried out.
    - Avoid working in confined spaces. Always ensure away from source, at least 2 meter of safety distance, or zoning of free space area of at least 2 meter in radius.
  - Checking for presence of refrigerant**
    - The area shall be checked with an appropriate refrigerant detector prior to and during work, to ensure the technician is aware of potentially flammable atmospheres.
    - Ensure that the leak detection equipment being used is suitable for use with flammable refrigerants, i.e. non sparking, adequately sealed or intrinsically safe.
    - In case of leakage/spillage happened, immediately ventilate area and stay upwind and away from spill/release.
    - In case of leakage/spillage happened, do notify persons down wind of the leaking/spill, isolate immediate hazard area and keep unauthorized personnel out.
  - Presence of fire extinguisher**
    - If any hot work is to be conducted on the refrigerating equipment or any associated parts, appropriate fire extinguishing equipment shall be available at hand.
    - Have a dry powder or CO<sub>2</sub> fire extinguisher adjacent to the charging area.
  - No ignition sources**
    - No person carrying out work in relation to a refrigerating system which involves exposing any pipe work that contains or has contained flammable refrigerant shall use any sources of ignition in such a manner that it may lead to the risk of fire or explosion. He/She must not be smoking when carrying out such work.
    - All possible ignition sources, including cigarette smoking, should be kept sufficiently far away from the site of installation, repairing, removing and disposal, during which flammable refrigerant can possibly be released to the surrounding space.
    - Prior to work taking place, the area around the equipment is to be surveyed to make sure that there are no flammable hazards or ignition risks.
    - "No Smoking" signs shall be displayed.
  - Ventilated area**
    - Ensure that the area is in the open or that it is adequately ventilated before breaking into the system or conducting any hot work.
    - A degree of ventilation shall continue during the period that the work is carried out.
    - The ventilation should safely disperse any released refrigerant and preferably expel it externally into the atmosphere.
  - Checks to the refrigerating equipment**
    - Where electrical components are being changed, they shall be fit for the purpose and to the correct specification.
    - At all times the manufacturer's maintenance and service guidelines shall be followed.
    - If in doubt consult the manufacturer's technical department for assistance.
    - The following checks shall be applied to installations using flammable refrigerants.
      - The actual refrigerant charge is in accordance with the room size within which the refrigerant containing parts are installed.
      - The ventilation machinery and outlets are operating adequately and are not obstructed.
      - If an indirect refrigerating circuit is being used, the secondary circuit shall be checked for the presence of refrigerant.
      - Marking to the equipment continues to be visible and legible. Markings and signs that are illegible shall be corrected.
      - Refrigerating pipe or components are installed in a position where they are unlikely to be exposed to any substance which may corrode refrigerant containing components, unless the components are constructed of materials which are inherently resistant to being corroded or are properly protected against being so corroded.

- Checks to electrical devices**
  - Repair and maintenance to electrical components shall include initial safety checks and component inspection procedures.
  - Initial safety checks shall include but not limit to:-
    - That capacitors are discharged: this shall be done in a safe manner to avoid possibility of sparking.
    - That there is no live electrical components and wiring are exposed while charging, recovering or purging the system.
    - That there is continuity of earth bonding.
  - At all times the manufacturer's maintenance and service guidelines shall be followed.
  - If in doubt consult the manufacturer's technical department for assistance.
  - If a fault exists that could compromise safety, then no electrical supply shall be connected to the circuit until it is satisfactorily dealt with.
  - If the fault cannot be corrected immediately but it is necessary to continue operation, an adequate temporary solution shall be used.
  - The owner of the equipment must be informed or reported so all parties are advised thereafter.
- Repairs to sealed components**
  - During repairs to sealed components, all electrical supplies shall be disconnected from the equipment being worked upon prior to any removal of sealed covers, etc.
  - If it is absolutely necessary to have an electrical supply to equipment during servicing, then a permanently operating form of leak detection shall be located at the most critical point to warn of a potentially hazardous situation.
  - Particular attention shall be paid to the following to ensure that by working on electrical components, the casing is not altered in such a way that the level of protection is affected. This shall include damage to cables, excessive number of connections, terminals not made to original specification, damage to seals, incorrect fitting of glands, etc.
  - Ensure that apparatus is mounted securely.
  - Ensure that seals or sealing materials have not degraded such that they no longer serve the purpose of preventing the ingress of flammable atmospheres.
  - Replacement parts shall be in accordance with the manufacturer's specifications.

**NOTE:**

  - The use of silicon sealant may inhibit the effectiveness of some types of leak detection equipment.
  - Intrinsically safe components do not have to be isolated prior to working on them.
- Repair to intrinsically safe components**
  - Do not apply any permanent inductive or capacitance loads to the circuit without ensuring that this will not exceed the permissible voltage and current permitted for the equipment in use.
  - Intrinsically safe components are the only types that can be worked on while live in the presence of a flammable atmosphere.
  - The test apparatus shall be at the correct rating.
  - Replace components only with parts specified by the manufacturer. Unspecified parts by manufacturer may result ignition of refrigerant in the atmosphere from a leak.
- Cabling**
  - Check that cabling will not be subject to wear, corrosion, excessive pressure, vibration, sharp edges or any other adverse environmental effects.
  - The check shall also take into account the effects of aging or continual vibration from sources such as compressors or fans.
- Detection of flammable refrigerants**
  - Under no circumstances potential sources of ignition be used in the searching or detection of refrigerant leaks.
  - A halide torch (or any other detector using a naked flame) shall not be used.
  - The following leak detection methods are deemed acceptable for all refrigerant systems.
    - No leaks shall be detected when using detection equipment with a sensitivity of 5 grams per year of refrigerant or better under a pressure of at least 0.25 times the maximum allowable pressure (>1.04MPa, max 4.15MPa) for example, a universal sniffer.
    - Electronic leak detectors may be used to detect flammable refrigerants, but the sensitivity may not be adequate, or may need re-calibration. (Detection equipment shall be calibrated in a refrigerant-free area.)
    - Ensure that the detector is not a potential source of ignition and is suitable for the refrigerant used.
    - Leak detection equipment shall be set at a percentage of the LFL of the refrigerant and shall be calibrated to the refrigerant employed and the appropriate percentage of gas (25 % maximum) is confirmed.
    - Leak detection fluids are also suitable for use with most refrigerants, for example, bubble method and fluorescent method agents. The use of detergents containing chlorine shall be avoided as the chlorine may react with the refrigerant and corrode the copper pipe-work.
    - If a leak is suspected, all naked flames shall be removed/extinguished.
    - If a leakage of refrigerant is found which requires brazing, all of the refrigerant shall be recovered from the system, or isolated (by means of shut off valves) in a part of the system remote from the leak. The precautions in #7 must be followed to remove the refrigerant.
- Removal and evacuation**
  - When breaking into the refrigerant circuit to make repairs – or for any other purpose – conventional procedures shall be used. However, it is important that best practice is followed since flammability is a consideration. The following procedure shall be adhered to:
    - remove refrigerant -> • purge the circuit with inert gas -> • evacuate -> • purge with inert gas -> • open the circuit by cutting or brazing
  - The refrigerant charge shall be recovered into the correct recovery cylinders.
  - The system shall be purged with OFN to render the appliance safe. (remark: OFN = oxygen free nitrogen, type of inert gas)
  - This process may need to be repeated several times.
  - Compressed air or oxygen shall not be used for this task.
  - Purging shall be achieved by breaking the vacuum in the system with OFN and continuing to fill until the working pressure is achieved, then venting to atmosphere, and finally pulling down to a vacuum.
  - This process shall be repeated until no refrigerant is within the system.
  - When the final OFN charge is used, the system shall be vented down to atmospheric pressure to enable work to take place.
  - This operation is absolutely vital if brazing operations on the pipe work are to take place.
  - Ensure that the outlet for the vacuum pump is not close to any potential ignition sources and there is ventilation available.
- Charging procedures**
  - In addition to conventional charging procedures, the following requirements shall be followed.
    - Ensure that contamination of different refrigerants does not occur when using charging equipment.
    - Hoses or lines shall be as short as possible to minimize the amount of refrigerant contained in them.
    - Cylinders shall be kept in an appropriate position according to the instructions.
    - Ensure that the refrigerating system is earthed prior to charging the system with refrigerant.
    - Label the system when charging is complete (if not already).
    - Extreme care shall be taken not to over fill the refrigerating system.
  - Prior to recharging the system it shall be pressure tested with OFN (refer to #7).
  - The system shall be leak tested on completion of charging but prior to commissioning.
  - A follow up leak test shall be carried out prior to leaving the site.
  - Electrostatic charge may accumulate and create a hazardous condition when charging and discharging the refrigerant. To avoid fire or explosion, dissipate static electricity during transfer by grounding and bonding containers and equipment before charging/discharging.
- Decommissioning**
  - Before carrying out this procedure, it is essential that the technician is completely familiar with the equipment and all its details.
  - It is recommended good practice that all refrigerants are recovered safely.
  - Prior to the task being carried out, an oil and refrigerant sample shall be taken in case analysis is required prior to re-use of recovered refrigerant.
  - It is essential that electrical power is available before the task is commenced.
    - Become familiar with the equipment and its operation.
    - Isolate system electrically.
    - Before attempting the procedure ensure that:
      - mechanical handling equipment is available, if required, for handling refrigerant cylinders;
      - all personal protective equipment is available and being used correctly;
      - the recovery process is supervised at all times by a competent person;
      - recovery equipment and cylinders conform to the appropriate standards.
    - Pump down refrigerant system, if possible.
    - If a vacuum is not possible, make a manifold so that refrigerant can be removed from various parts of the system.
  - Electrostatic charge may accumulate and create a hazardous condition when charging or discharging the refrigerant. To avoid fire or explosion, dissipate static electricity during transfer by grounding and bonding containers and equipment before charging/discharging.
- Labelling**
  - Equipment shall be labelled stating that it has been de-commissioned and emptied of refrigerant.
  - The label shall be dated and signed.
  - Ensure that there are labels on the equipment stating the equipment contains flammable refrigerant.
- Recovery**
  - When removing refrigerant from a system, either for servicing or decommissioning, it is recommended good practice that all refrigerants are removed safely.
  - When transferring refrigerant into cylinders, ensure that only appropriate refrigerant recovery cylinders are employed.
  - Ensure that the correct number of cylinders for holding the total system charge are available.
  - All cylinders to be used are designated for the recovered refrigerant and labelled for that refrigerant (i.e. special cylinders for the recovery of refrigerant).
  - Cylinders shall be complete with pressure relief valve and associated shut-off valves in good working order.
  - Recovery cylinders are evacuated and, if possible, cooled before recovery occurs.
  - The recovery equipment shall be in good working order with a set of instructions concerning the equipment that is at hand and shall be suitable for the recovery of concerning the equipment that is at hand and shall be suitable for the recovery of flammable refrigerants.
  - In addition, a set of calibrated weighing scales shall be available and in good working order.
  - Hoses shall be complete with leak-free disconnect couplings and in good condition.
  - Before using the recovery machine, check that it is in satisfactory working order, has been properly maintained and that any associated electrical components are sealed to prevent ignition in the event of a refrigerant release. Consult manufacturer if in doubt.
  - The recovered refrigerant shall be returned to the refrigerant supplier in the correct recovery cylinder, and the relevant Waste Transfer Note arranged.
  - Do not mix refrigerants in recovery units and especially not in cylinders.
  - If compressors or compressor oils are to be removed, ensure that they have been evacuated to an acceptable level to make certain that flammable refrigerant does not remain within the lubricant.
  - The evacuation process shall be carried out prior to returning the compressor to the suppliers.
  - Only electric heating to the compressor body shall be employed to accelerate this process.
  - When oil is drained from a system, it shall be carried out safely.

Explanation of symbols displayed on the indoor unit or outdoor unit.

WARNING, CAUTION symbols and their explanations regarding flammable refrigerant, operating instructions, and service personnel handling.

Check of Density Limit

The refrigerant (R32), which is used in the air conditioner, is a flammable refrigerant. So the requirements for installation space of appliance are determined according to the refrigerant charge amount (m) used in the appliance.

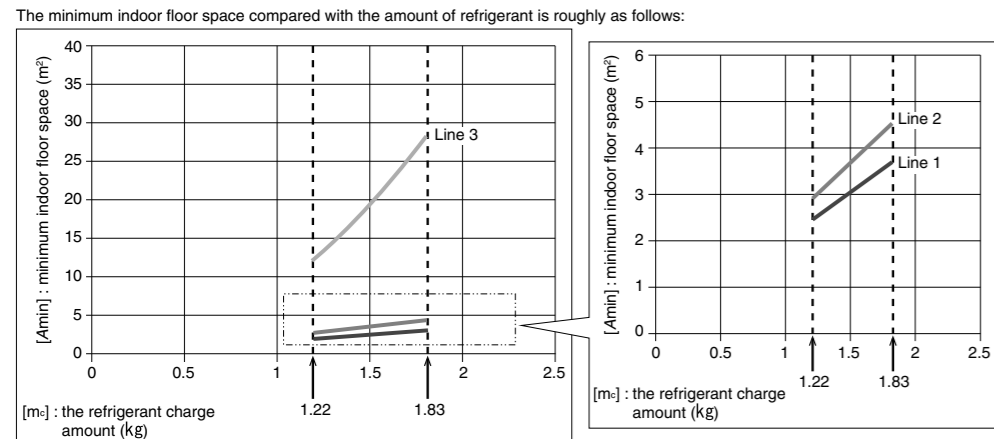

Table 1: Installation height of Indoor Unit, Indoor Unit Type, and Density Limit Line. Includes a table for refrigerant charge amount (m) for different models.

m : The refrigerant charge amount (Total of refrigerant at shipment and refrigerant charge amount in the field). Please calculate m according to piping length in the field as shown in the calculation example below.

- 1: Refrigerant charged at shipment, 2: Refrigerant charge amount in the field, 3: Additional charge per 1m, 4: Total pipe length, 5: Charge-less pipe length(max).

Please install according to 'Warning' 'Caution' on page 1.

1. SELECT THE OUTDOOR UNIT INSTALLATION LOCATION

- Warning: Be careful when picking up and moving the indoor and outdoor units. Get a partner to help, and bend your knees when lifting to reduce strain on your back.

- 1. Install the unit once you have checked that the installation location matches the following conditions. 2. Refer to the diagram below for the installation location which is exposed to strong wind.

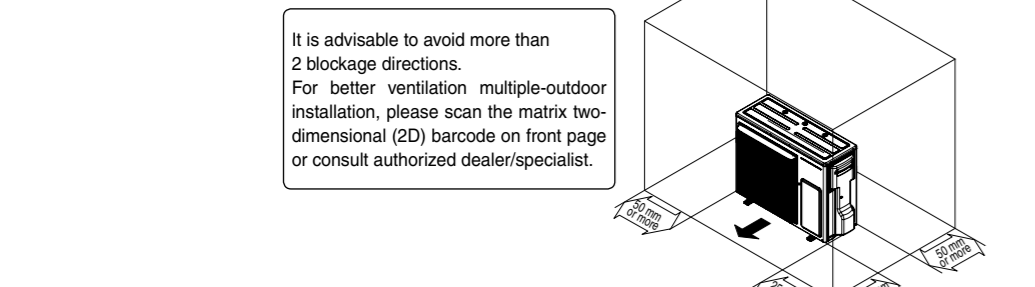

2. TRANSPORT AND INSTALL THE OUTDOOR UNIT

- Transporting: Transport the outdoor unit in its original packaging as close as possible to the installation location. Installation: Read the 'Select the outdoor unit installation location' thoroughly before installing the outdoor unit.

Table with columns: Model, A, B, C, D. Dimensions for models U-36PZ3E5, U-50PZ3E5, U-60PZ3E5, and U-71PZ3E5.

3. REFRIGERANT INSTALLATION

- For indoor unit refrigerant piping installation, refer to the installation instruction manual that comes with that indoor unit. 1. Precautions during refrigerant installation. Use clean pipes with no dust inside.

Specification for pipe connecting indoor unit to outdoor unit. Table with columns: Pipe outer diameter, Maximum pipe length, Maximum elevation, Charge-less pipe length, Additional charge per 1 m, Refrigerant charged at shipment, Total refrigerant amount.

Piping Thickness: Table with columns: Size mm (in.), Thickness mm. Values for different pipe diameters.

Precautions when operating the 2/3-way valve for piping installation

- Do not open the 2/3-way valve until the piping installation is completed. It is closed during shipment. When removing or tightening the gas tube flare nut, use 2 adjustable wrenches together.

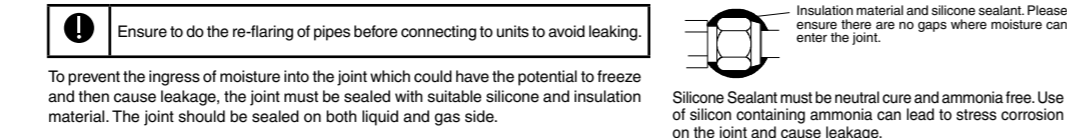

Precautions for handling the valve cap

- Ensure not to scratch the inner surface of the valve or the end of the valve shaft. Once adjustments to the valve are completed, ensure to tighten the valve cap according to the prescribed torque.

Precautions for handling the service ports

- Use a push-rod with a charge hose. Once adjustments to the valve are completed, ensure to tighten the valve cap according to the prescribed torque.

Precautions for connecting the pipes

- For proper connection, align the union and flare straight with each other. Ensure that the pipes do not come into contact with the compressor's bolts or exterior panel.

- Precautions for insulation installation: In high humidity environment, reinforce the insulation material for the refrigerant piping. Failure to do so may result in condensation on the surface of the insulation material.

Precautions for flare nut installation: Table with columns: Piping size, Tightening torque (approx.), Flare section dimensions A, Flare configuration.

- After piping connection has completed, ensure there is no gas leakage. When tightening the flare nut, coat the flares (inner surface only) with refrigerant oil on the flares.

IN CASE OF REUSING EXISTING REFRIGERANT PIPING

- Observe the followings to decide reusing the existing refrigerant piping. Poor refrigerant piping could result in product failure. In the circumstances listed below, do not reuse any refrigerant piping.

4. AIR TIGHTNESS TEST ON THE REFRIGERATING SYSTEM

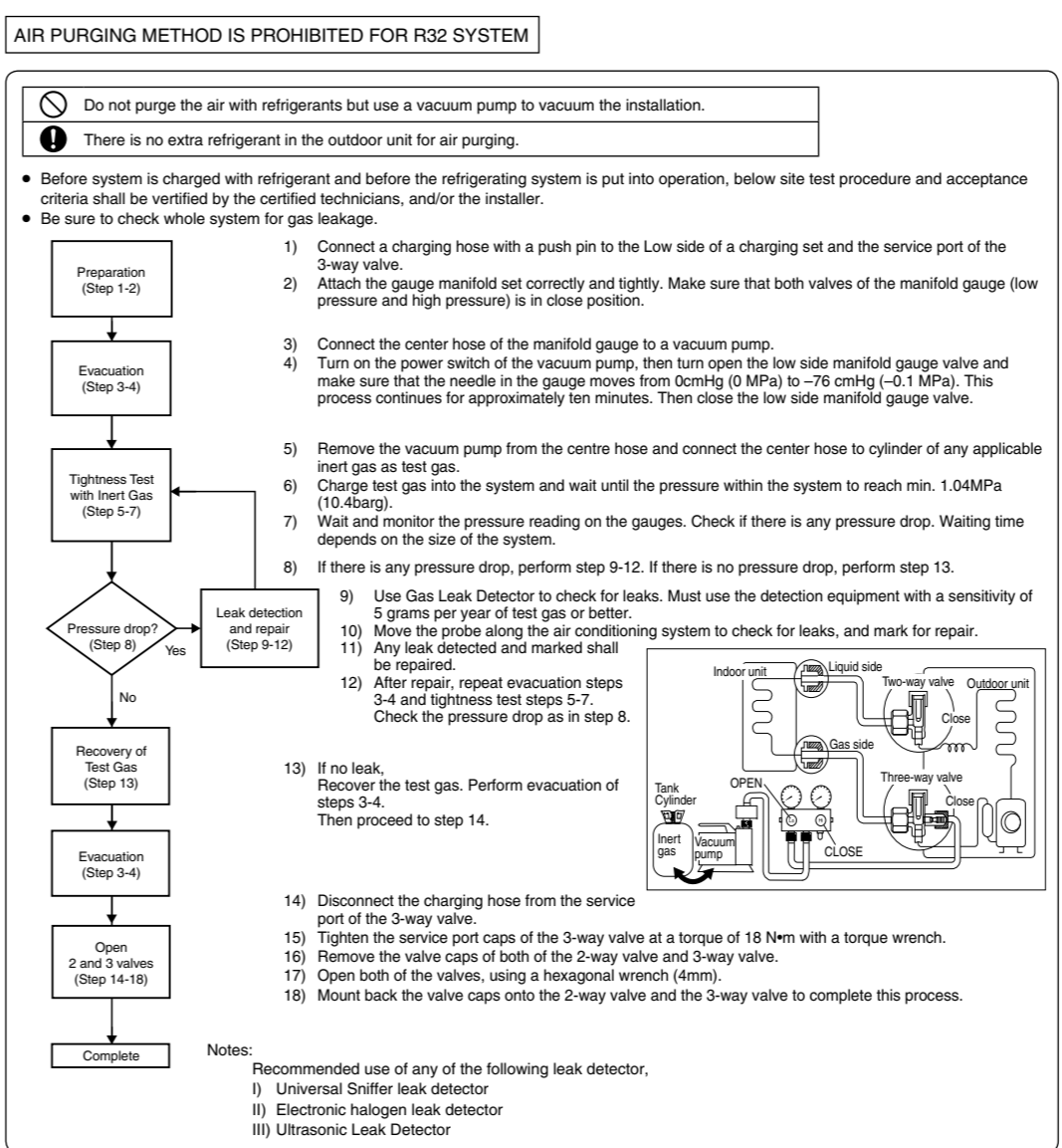

5. REGARDING REFRIGERANT FILLING

- Precautions during refrigerant filling: Use tools that are designed specifically for R32, for pressure resistance and to prevent mixing impurities. Fill the refrigerant from the 3-way valve's service port on the liquid-side.

6. ELECTRICAL WIRING

Warning: This air conditioner must be installed in accordance with national wiring regulations. Cables connected to outdoor unit must be approved polychloroprene sheathed type 60245 IEC 57 or H05RN-F/H07RN-F or heavier.

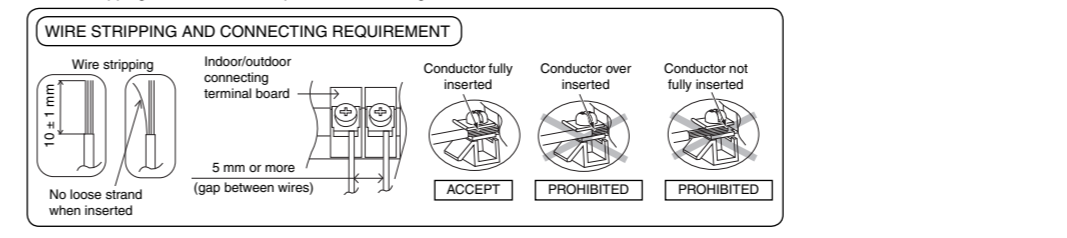
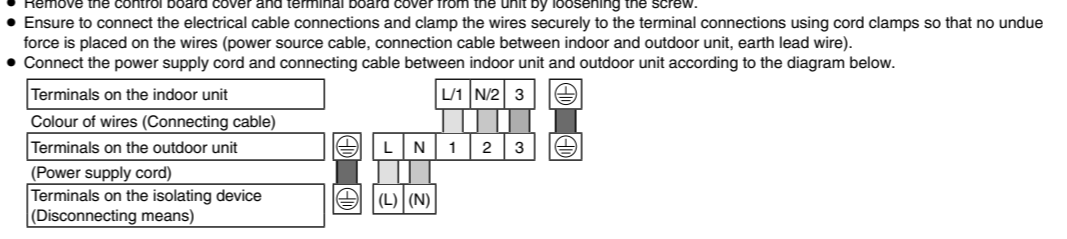

- Do not install a phase advance capacitor for power factor improvement. Do not bind the excess cables together and place them inside this unit. Make sure that terminal board cover and control board cover mount correctly.

OUTDOOR UNIT/SINGLE-PHASE MODEL

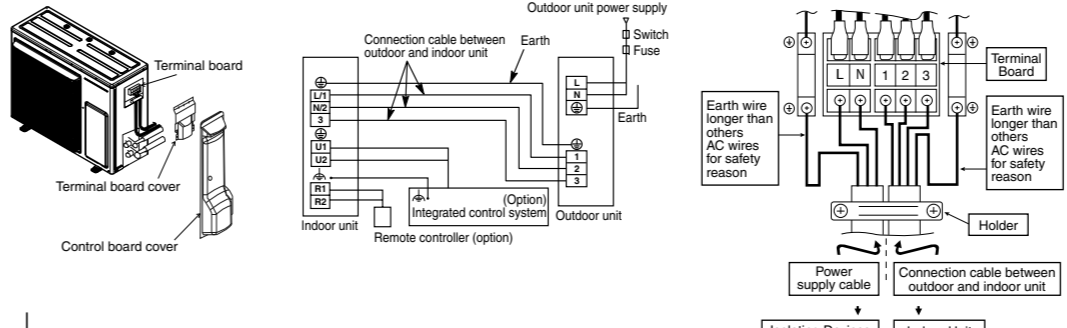

: functional earthing (for the shielded cable)

Table with columns: Model, (A) Power supply cable, Min. wire size (mm²), Time delay fuse or circuit capacity (A). Models include U-36PZ3E5, U-50PZ3E5, U-60PZ3E5, and U-71PZ3E5.

Table with columns: Type, Connection cable between outdoor and indoor unit, Outdoor unit, Max. length. Type is 1.5 mm², Max. length is 40 m.

- Refer to the installation instruction manual provided with the indoor unit. The product meets the technical requirements of EN/IEC 61000-3-3. Decide the length and size of the power supply cable based on the maximum ampere tabulated above.

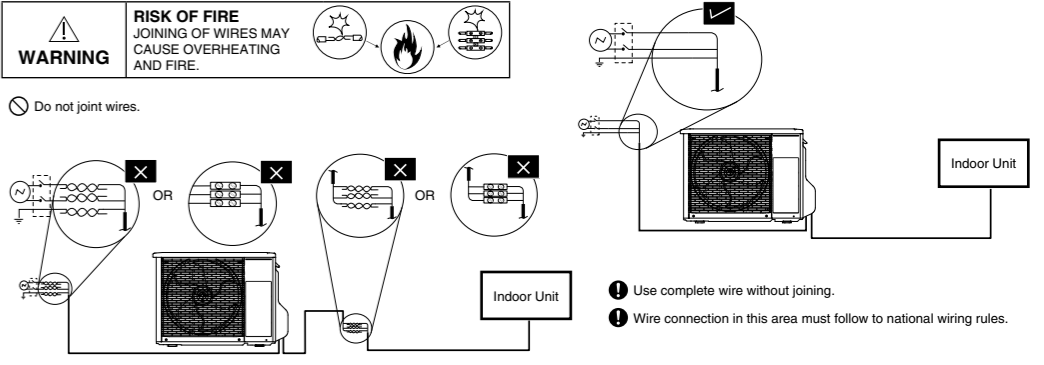

7. PRECAUTIONS REGARDING TEST RUN

Check Before Test Run: Content check (Power supply cable, Earth wire, Refrigerant pipe) and Test Run Procedure (Never switch the power supply ON until the installation has completed).

- Never switch the power supply ON until the installation has completed. Supply electrical current through all indoor units and check the voltage. Supply electrical current through all the outdoor units and check each inter-phase voltage.

Test Run Procedure

Refer to the installation instruction manual provided with the indoor unit.

8. CHECKS AFTER INSTALLATION HAVE COMPLETED

- Check the following items after completing installation. Is there a short circuit with the intake air flow? Is the insulation secure? (Refrigerant piping) Are there any errors with the wiring?

9. REGARDING DELIVERY TO THE CUSTOMER

- Request the customer to review the operating instructions and explain the operating method for the product. In addition, it is also recommended that regular inspection checks are agreed upon for maintenance.

Refer to the installation instruction manual provided with the indoor unit for the specifications on the indoor unit installation.